



**Model Number**

**OBE500-R2F-SE0-Y253561**

Thru-beam sensor (pair)  
with 2 m fixed cable

**Features**

- Very flat design for direct mounting without mounting bracket
- TEACH-IN
- Detection of partially transparent objects by teach-in
- Very bright, highly visible light spot

**Dimensions**

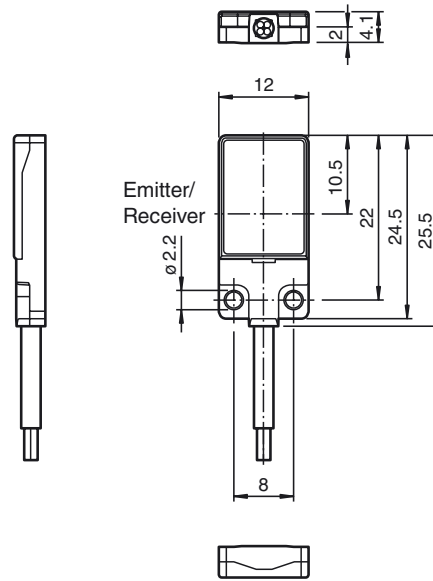

**Electrical connection**

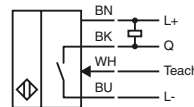
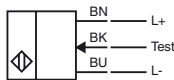

**Technical data****System components**

Emitter	OBE500-R2F-S
Receiver	OBE500-R2F-E0-Y813034

**General specifications**

Effective detection range 0 ... 500 mm

Threshold detection range 700 mm

Light source LED

Light type modulated visible red light , 630 nm

LED risk group labelling exempt group

Angle deviation approx. 2 °

Object size typ. starts from 1.5 mm

Diameter of the light spot approx. 60 mm at a distance of 500 mm

Angle of divergence approx. 5 °

Optical face frontal

Ambient light limit EN 60947-5-2 : 25000 Lux

**Functional safety related parameters**

MTTF<sub>d</sub> 806 a

Mission Time (T<sub>M</sub>) 20 a

Diagnostic Coverage (DC) 0 %

**Indicators/operating means**

Operation indicator LED green, statically lit Power on , short-circuit : LED green flashing (approx. 4 Hz)

Function indicator Receiver: LED yellow, lights up when light beam is free, flashes when falling short of the stability control ; OFF when light beam is interrupted

**Electrical specifications**

Operating voltage U<sub>B</sub> 10 ... 30 V DC

No-load supply current I<sub>0</sub> < 10 mA

Protection class III

**Input**

Test input Test of switching function at 0 V

Switching threshold Teach-In input

**Output**

Switching type NO contact / dark on

Signal output 1 NPN output, short-circuit protected, reverse polarity protected, open collector

Switching voltage max. 30 V DC

Switching current max. 50 mA , resistive load

Voltage drop U<sub>d</sub> ≤ 1.5 V DC

Switching frequency f approx. 1 kHz

Response time 500 μs

**Directive conformity**

Electromagnetic compatibility

Directive 2014/30/EU EN 60947-5-2:2007 EN 60947-5-2/A1:2012

**Standard conformity**

Standards EN 60947-5-2:2007 EN 60947-5-2/A1:2012 EN 62471:2008 UL 60947-5-2: 2014

**Ambient conditions**

Ambient temperature -20 ... 60 °C (-4 ... 140 °F)

Storage temperature -20 ... 70 °C (-4 ... 158 °F)

**Mechanical specifications**

Degree of protection IP67

Connection 2 m fixed cable

Material

Housing PC (Polycarbonate) and Stainless steel

Optical face PMMA

Cable PUR

Mass approx. 20 g Per sensor

Tightening torque, fastening screws 0.25 Nm

Cable length 2 m

**Approvals and certificates**

UL approval E87056 , cULus Recognized, Class 2 Power Source

CCC approval CCC approval / marking not required for products rated ≤36 V

Other suitable accessories can be found at

**Curves/Diagrams**

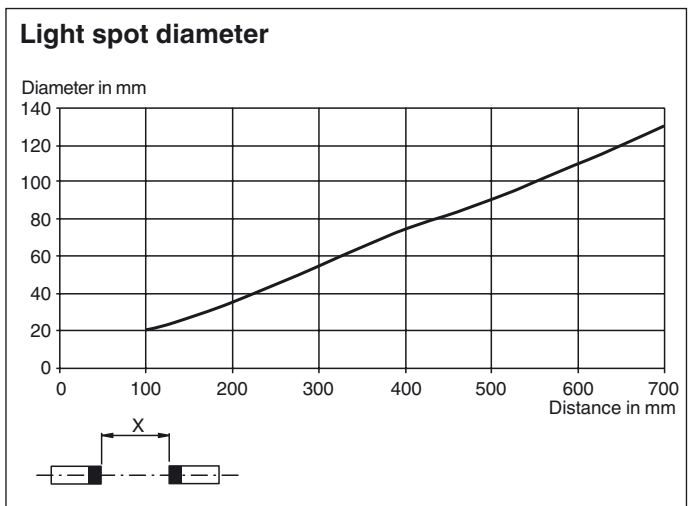
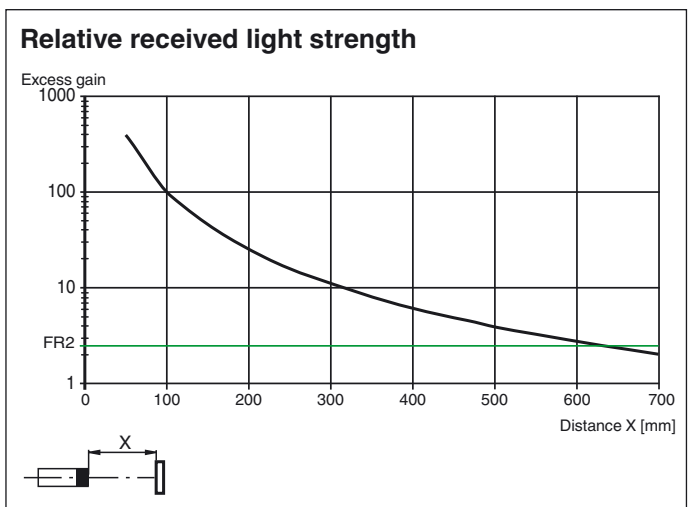
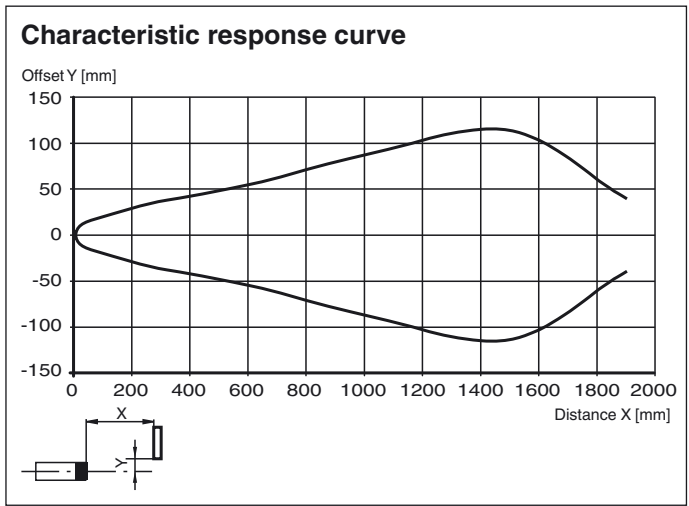

**Teach-In Methods**

The thru-beam sensor enables the switching points to be taught in for optimum adaptation to specific applications. This eliminates the need for additional components such as apertures.

The sensitivity of the thru-beam sensor can be adjusted using three Teach-in methods:

**Position Teach**

When using this Teach-in method, the following settings are made on the thru-beam sensor:

- The gain is set to an optimum value
- The signal threshold is set to a minimum

Release date: 2017-02-16 13:18 Date of issue: 2017-02-22 253561\_eng.xml

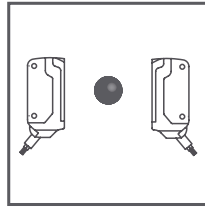
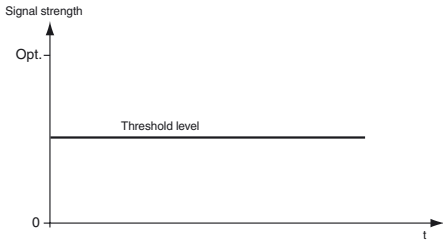

**Recommended application:**

This method enables minuscule particles in the beam path to be detected, and provides exceptional positioning accuracy. Make sure that there are no objects in the beam path and that the sensor is connected to the power supply.

1. Connect the white cable on the receiver (WH/IN) to the blue cable (BU/0 V) on the receiver. The green and yellow LED indicators flash simultaneously at 2.5 Hz
2. Disconnect the white cable on the receiver (WH/IN) from the blue cable (BU/0 V) on the receiver. The green and yellow LED indicators flash alternately at 2.5 Hz
3. The end of the Teach-in process is indicated when the green LED indicator lights up solid and yellow LED blinks.

**Two-Point Teach-In**

When using this Teach-in method, the following settings are made on the thru-beam sensor:

- The gain is set to an optimum value
- The signal threshold is set in the center between the two taught signal values

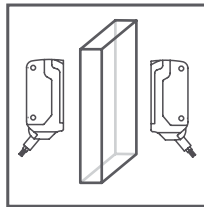
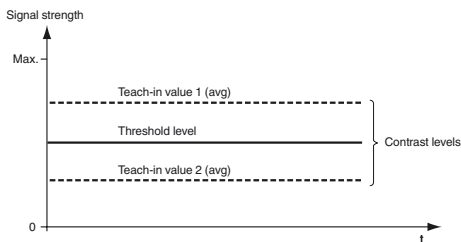

1. Make sure that there are no objects in the beam path and that the sensor is connected to the power supply.
2. Connect the white cable on the receiver (WH/IN) to the blue cable (BU/0 V) on the receiver. The green and yellow LED indicators flash simultaneously at 2.5 Hz
3. Position the object in the beam path.
4. Disconnect the white cable on the receiver (WH/IN) from the blue cable (BU/0 V) on the receiver. The green and yellow LED indicators flash alternately at 2.5 Hz
5. The end of the Teach-in process is indicated when the green LED indicator lights up solid.

**Maximum Teach-In**

When using this Teach-in method, the following settings are made on the thru-beam sensor:

- The gain is set to a maximum
- The signal threshold is set to a minimum

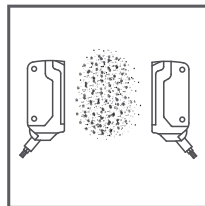
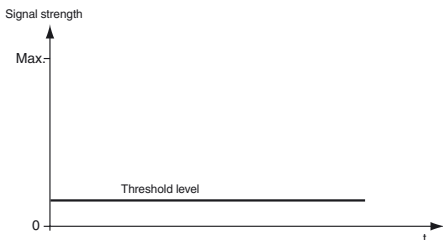

**Recommended application:**

Enables an object to be detected with a high excess gain. This can be useful if there is severe environmental contamination or to achieve long operating times.

Make sure that there are no objects in the beam path and that the sensor is connected to the power supply.

6. Cover the receiver or transmitter.
7. Connect the white cable on the receiver (WH/IN) to the blue cable (BU/0 V) on the receiver. The green and yellow LED indicators flash simultaneously at 2.5 Hz
8. Disconnect the white cable on the receiver (WH/IN) from the blue cable (BU/0 V) on the receiver. The green and yellow LED indicators flash alternately at 2.5 Hz
9. The end of the Teach-in process is indicated when the green LED indicator lights up solid.